

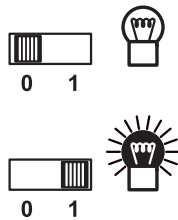

Modell des Schnellzugwagens

35513

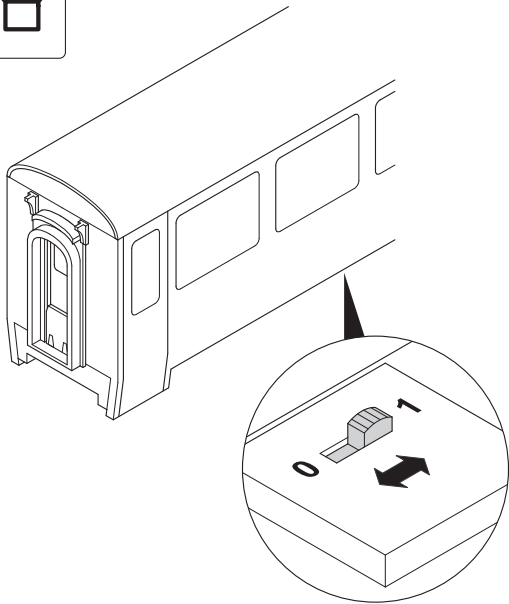

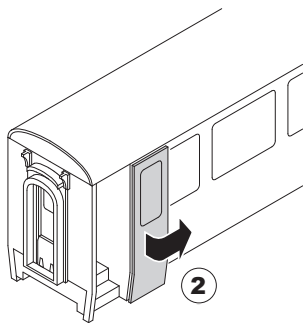
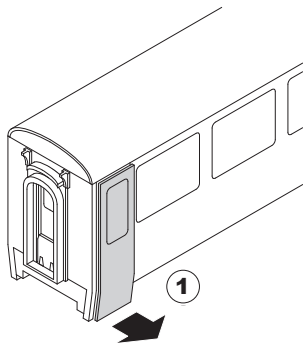
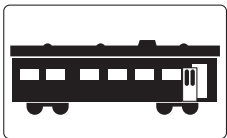

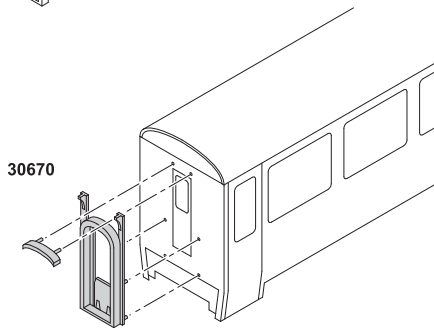
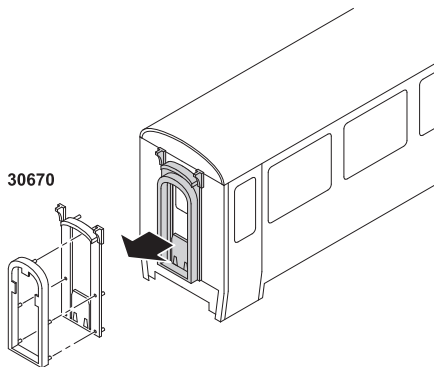
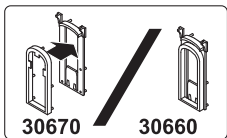

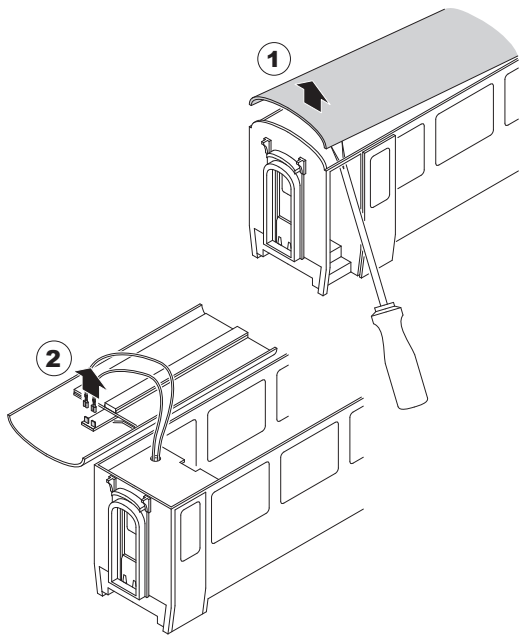
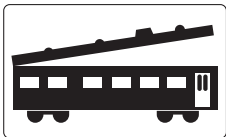

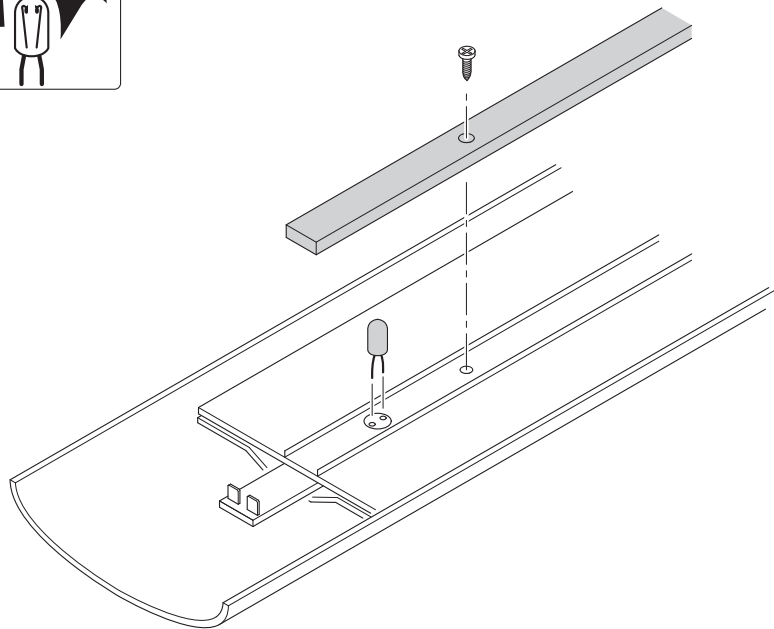
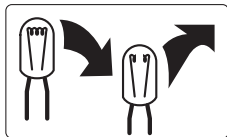

Ersatzteile

Kupplung	E130 547
Faltenbalg u. Faltenbalgdach	E251 113
Lagerplatten	E185 045
Faltenbalg Innen u. Außenteil	E248 721
Puffer	E253 167
Kabel, Schläuche	E253 168
Beilagscheibe 9 mm	E124 208
Schraube 3,0 x 9,5	E124 197
Schraube 2,2 x 6,5	E124 010
Schraube 3,0 x 6,5	E124 014
Drehgestell ohne Haken	E251 063
Drehgestell mit Haken	E251 067
Kupplung	E171 327
Kugellager-Radsatz	67 403
Metall-Scheibenradsatz	67 419

Gebr. Märklin & Cie. GmbH
Stuttgarter Straße 55 - 57
73033 Göppingen
Germany
www.lgb.de



www.maerklin.com/en/imprint.html

251073/1115/Sm1Ef
Änderungen vorbehalten
© Gebr. Märklin & Cie. GmbH